



Model Number

V1S-W-BK5M-PVC-U

Cable connector, M12, 4-pin, PVC cable

Features

- UL Recognized Component
- Knurled nut suitable for tool assembly
- Immunity to vibration, with mechanical latching
- Gold plated contacts
- Degree of protection IP67 / IP68 / IP69K

Dimensions

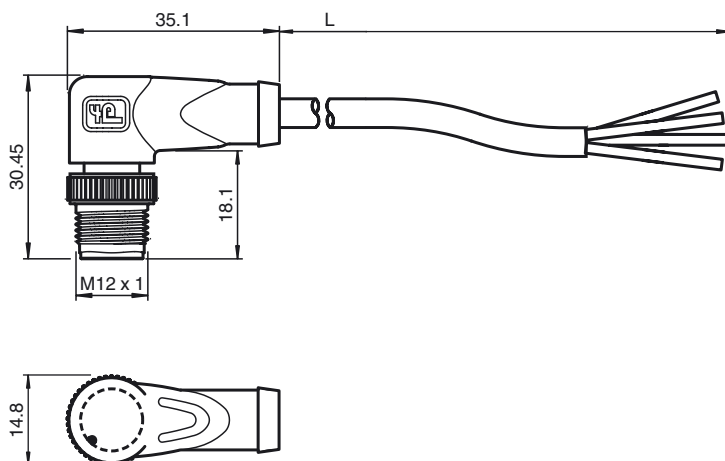

Technical data

General specifications

Number of pins	4
Connection 1	Male connector
Construction type 1	right angle
Threading 1	M12
Connection 2	cable end
UL File Number	E231213

Electrical specifications

Operating voltage	U_B	max. 250 V AC/DC
Operating current	I_B	max. 4 A
Volume resistance		< 5 m Ω

Ambient conditions

Ambient temperature	Body: -40 ... 90 °C (-40 ... 194 °F) cable, flexing: -25 ... 80 °C (-13 ... 176 °F) cable, fixed: -5 ... 80 °C (23 ... 176 °F)
Pollution degree	3

Mechanical specifications

Pin diameter	1 mm
Degree of protection	IP67 / IP68 / IP69k
Material	
Contacts	CuSn / Au
Contact surface	Au
Body	TPU, black
Cable	PVC
Sleeve connector	Diecast zinc
Core insulation	PVC
Cable	fine-strand, flexible
Sheath diameter	Ø 4.3 mm
Bending radius	> 15 x cable diameter, moving > 5 x cable diameter, fixed
Color	black
Number of cores	4
Core cross-section	0.34 mm ²
Conductor construction	19 x 0.15 mm Ø
Length	L 5 m
Flammability	
Contact carrier	94 HB
Housing	94 V-2
Cable	FT1

Compliance with standards and directives

Standard conformity	
Degree of protection	EN 60529:2000
Standards	IEC 61076-2-101:2008

Electrical connection





Flammability	Body: UL 94 Line: UL 1581 Section 1061; IEC 60332-1-2:2004
Halogen-free	IEC 60754-1:1994

Approvals and certificates

UL approval	UL Recognized General purpose
Maximum permissible operating voltage	≤ 30 V
Maximum permissible ambient temperature	≤ 80 °C (≤ 176 °F)

Release date: 2018-06-04 10:32 Date of issue: 2018-06-04 240772-100013_eng.xml